



## X150 SERIES 150 WATT HIGH VOLTAGE DC/DC CONVERTERS

### FEATURES

- ▶ **Customer Selects Output Voltage**
- ▶ Ultra Wide Input Ranges  
*(18-36Vdc , 20-60Vdc , 36-72Vdc)*
- ▶ Efficiency 90% (typ.)
- ▶ Independently Isolated Outputs
- ▶ Six-Sided Shielded Case
- ▶ Remote On/Off Control
- ▶ Continuous Short Circuit Protection



The X150 Series of DC/DC converters accepts ultra wide input ranges of 18-36 Vdc, 20-60 Vdc and 36-72 Vdc. Outputs are independently isolated. In the case of duals, up to 120 watts may be taken from either output. All models will tolerate a short circuit indefinitely. Also included is a Pi input filter and remote on/off.

### ELECTRICAL SPECIFICATIONS

Voltage Accuracy .....	+/- 1%	Input Filter .....	Pi Network
Line Regulation .....	+/- 0.2%	Efficiency .....	90% (typ.)
Load Regulation .....	+/- 0.3%	Short Circuit Protection .....	Continuous
Output Ripple .....	< 0.3% P-P	Switching Frequency .....	120 kHz
		Isolation (Input-Output(1)-Output(2)-Case) .....	1000 Vdc
		Input / Output Capacitance .....	< 200pF

### GENERAL SPECIFICATIONS

Temp. Stability .....	+/-0.02%/°C	Logic Shutdown .....	Logic 0 (on)
Temp. (Operating , Case) .....	-45 to +85°C	EMI/RFI .....	Six Sided Shield
Temp. (Storage) .....	-55 to +100°C	Derating .....	None
		Cooling .....	Free-Air Convection

### PHYSICAL SPECIFICATIONS

Dimensions .....	3.5 x 5.5 x 0.92 inches	Case Material .....	Black Coated Metal
Weight .....	18.5 Oz		<i>(With Non-Conductive Base Plate)</i>



## X150 SERIES 150 WATT HIGH VOLTAGE DC/DC CONVERTERS

REPRESENTATIVE MODEL LISTING									
OUTPUT SPECS				MODEL NUMBER / INPUT RANGE					
VOLTAGE		CURRENT		18-36VDC		20-60VDC		36-72VDC	
OUT #1	OUT #2	OUT #1	OUT #2	Non-RoHs	RoHs	Non-RoHs	RoHs	Non-RoHs	RoHs
48 Vdc	-	3 A	-	X150-48	X150-48/Y	X150-48/B	X150-48/B/Y	X150-48/C	X150-48/C/Y
48 Vdc	48Vdc	1.5 A	1.5 A	X150-48/48	X150-48/48/Y	X150-48/48/B	X150-48/48/B/Y	X150-48/48/C	X150-48/48/C/Y
50 Vdc	-	3 A	-	X150-50	X150-50/Y	X150-50/B	X150-50/B/Y	X150-50/C	X150-50/C/Y
50Vdc	50 Vdc	1.5 A	1.5 A	X150-50/50	X150-50/50/Y	X150-50/50/B	X150-50/50/B/Y	X150-50/50/C	X150-50/50/C/Y
75Vdc	-	2 A	-	X150-75	X150-75/Y	X150-75/B	X150-75/B/Y	X150-75/C	X150-75/C/Y
75 Vdc	75 Vdc	1 A	1 A	X150-75/75	X150-75/75/Y	X150-75/75/B	X150-75/75/B/Y	X150-75/75/C	X150-75/75/C/Y
100 Vdc	-	1.5 A	-	X150-100	X150-100/Y	X150-100/B	X150-100/B/Y	X150-100/C	X150-100/C/Y
100 Vdc	100Vdc	750 mA	750 mA	X150-100/100	X150-100/100/Y	X150-100/100/B	X150-100/100/B/Y	X150-100/100/C	X150-100/100/C/Y
150 Vdc	-	1 A	-	X150-150	X150-150/Y	X150-150/B	X150-150/B/Y	X150-150/C	X150-150/C/Y
150 Vdc	150 Vdc	500 mA	500 mA	X150-150/150	X150-150/150/Y	X150-150/150/B	X150-150/150/B/Y	X150-150/150/C	X150-150/150/C/Y
200 Vdc	-	750 mA	-	X150-200	X150-200/Y	X150-200/B	X150-200/B/Y	X150-200/C	X150-200/C/Y
200Vdc	200Vdc	375 mA	375 mA	X150-200/200	X150-200/200/Y	X150-200/200/B	X150-200/200/B/Y	X150-200/200/C	X150-200/200/C/Y
300 Vdc	-	500 mA	-	X150-300	X150-300/Y	X150-300/B	X150-300/B/Y	X150-300/C	X150-300/C/Y
300 Vdc	300 Vdc	250 mA	250 mA	X150-300/300	X150-300/300/Y	X150-300/300/B	X150-300/300/B/Y	X150-300/300/C	X150-300/300/C/Y
400Vdc	-	375 mA	-	X150-400	X150-400/Y	X150-400/B	X150-400/B/Y	X150-400/C	X150-400/C/Y
400Vdc	400 Vdc	187 mA	187 mA	X150-400/400	X150-400/400/Y	X150-400/400/B	X150-400/400/B/Y	X150-400/400/C	X150-400/400/C/Y
500 Vdc	-	300 mA	-	X150-500	X150-500/Y	X150-500/B	X150-500/B/Y	X150-500/C	X150-500/C/Y
500 Vdc	500Vdc	150 mA	150 mA	X150-500/500	X150-500/500/Y	X150-500/500/B	X150-500/500/B/Y	X150-500/500/C	X150-500/500/C/Y

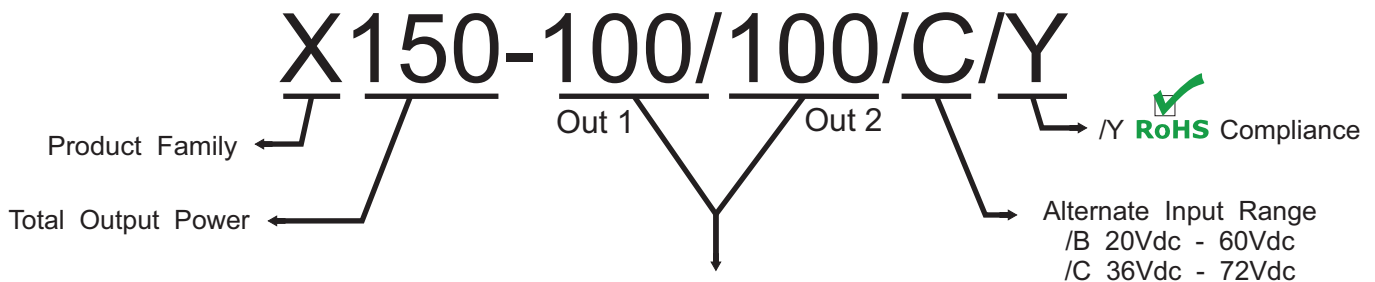

### Customer Selects Output Voltage

The X150 Series are designed such that the customer may order any output voltage from 48Vdc to 500Vdc at no additional charge.



## X150 SERIES 150 WATT HIGH VOLTAGE DC/DC CONVERTERS

### STANDARD PC MOUNT

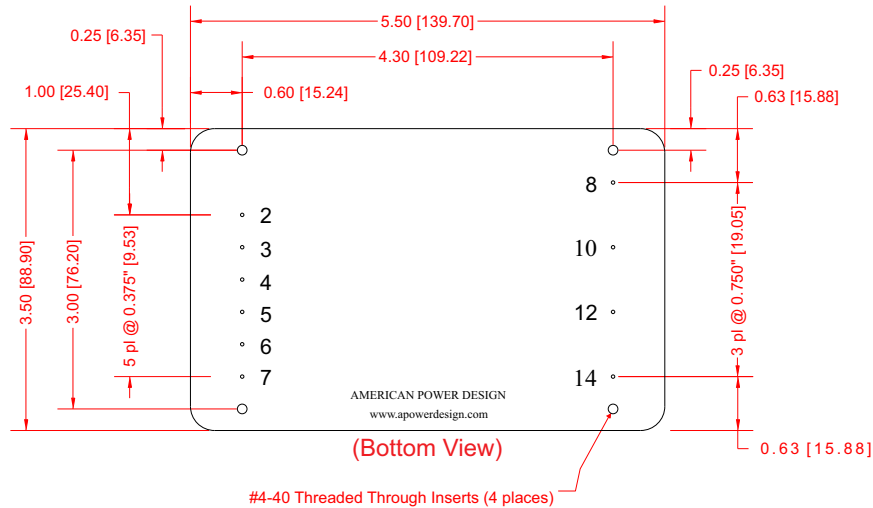

Dimensions are in Inches  
[Metric equivalents in brackets]

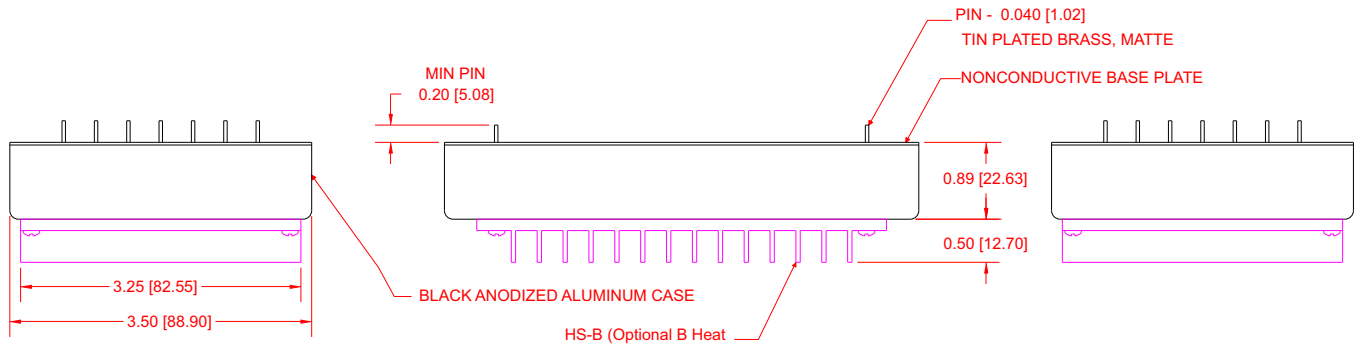

PIN #	FUNCTION		PIN #	FUNCTION	
	Single	Dual		Single	Dual
1	No Pin	No Pin	8	No Pin	Output 2 +
2	- Input	- Input	9	No Pin	No Pin
3	- Input	- Input	10	No Pin	Output 2 -
4	+ Input	+ Input	11	No Pin	No Pin
5	+ Input	+ Input	12	Output 1 +	Output 1 +
6	On / Off	On / Off	13	No Pin	No Pin
7	Case	Case	14	Output 1 -	Output 1 -



# X150 SERIES 150 WATT HIGH VOLTAGE DC/DC CONVERTERS

## -TS CHASSIS MOUNT OPTION

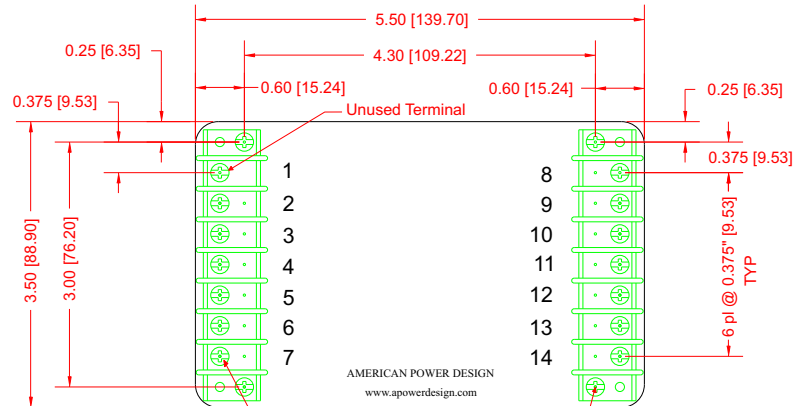

(Bottom View)

Dimensions are in Inches  
 [Metric equivalents in brackets]

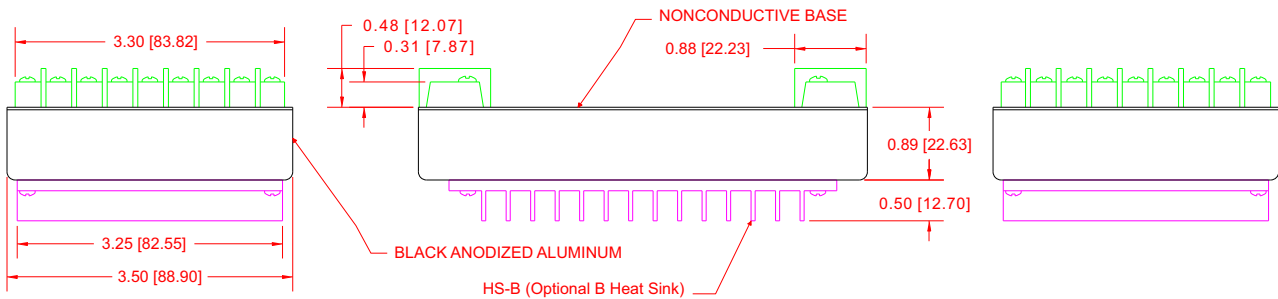

PIN #	FUNCTION		PIN #	FUNCTION	
	Single	Dual		Single	Dual
1	N/C	N/C	8	N/C	Output 2 +
2	- Input	- Input	9	N/C	N/C
3	- Input	- Input	10	N/C	Output 2 -
4	+ Input	+ Input	11	N/C	N/C
5	+ Input	+ Input	12	Output 1 +	Output 1 +
6	On / Off	On / Off	13	N/C	N/C
7	Case	Case	14	Output 1 -	Output 1 -



## X150 SERIES 150 WATT HIGH VOLTAGE DC/DC CONVERTERS

### APPLICATION NOTES

#### INPUT AND OUTPUT IMPEDANCE

The X150 Series of power converters have been designed to be stable with no external capacitors when used in low inductance input and output circuits. However, in some applications, the inductance associated with the distribution from the power source to the input of the converter can affect the stability of the converter. The addition of a 100  $\mu\text{F}$  electrolytic capacitor with an ESR  $< 1$  Ohm across the input helps ensure stability of the converter. In many applications, the user has to use decoupling capacitance at the load.

#### SHORT CIRCUIT PROTECTION

The X150 Series is equipped with short circuit protection. The converter will fold-back the input power whenever a short circuit is applied to its output and automatically recover after the overload condition is removed.

#### ISOLATION

The output(s) of the X150 Series is galvanically isolated from both the input and case, capacitance is  $< 200$  pF and resistance is  $> 10\text{G}$  Ohm.

In the case of dual's, the outputs are independently isolated from one another as well as the input and case.

#### RIPPLE AND NOISE

Figure below shows a typical output voltage ripple waveform, measured at full rated load current with no additional output filtering. External low ESR capacitors may be added across output to further reduce ripple.

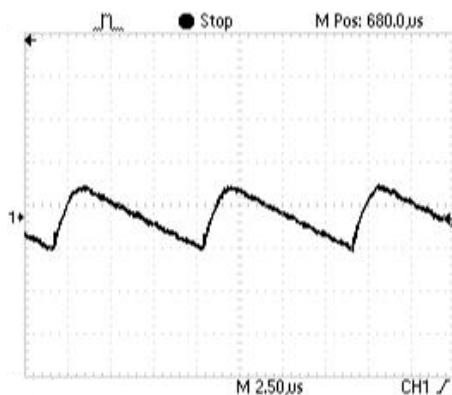

#### STARTUP TRANSIENT

Figure below shows a typical output voltage during turn-on, measured at no load current with no additional output filtering.

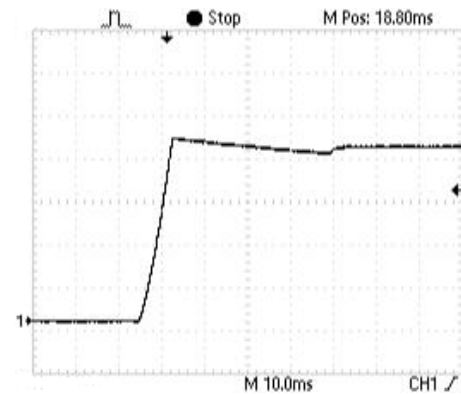
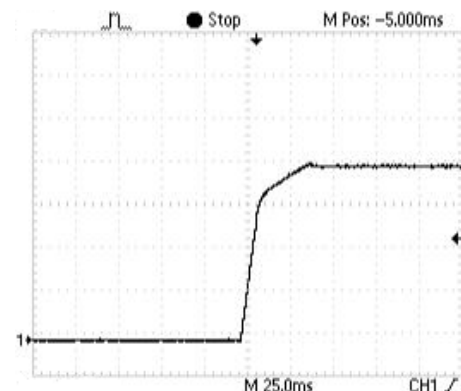

Figure below shows a typical output voltage during turn-on, measured at full rated load current with no additional output filtering.





## X150 SERIES 150 WATT HIGH VOLTAGE DC/DC CONVERTERS

### APPLICATION NOTES

#### INRUSH CURRENT

The inrush current of the X150 Series has been kept as low as possible. However, a series resistor may be inserted in the input line to limit this current further.

#### LOAD TRANSIENT

Figure below shows a typical output voltage response, measured during a transition from full rated load current to no load current with no additional output filtering.

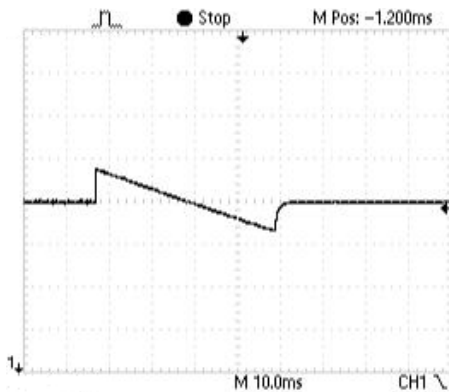
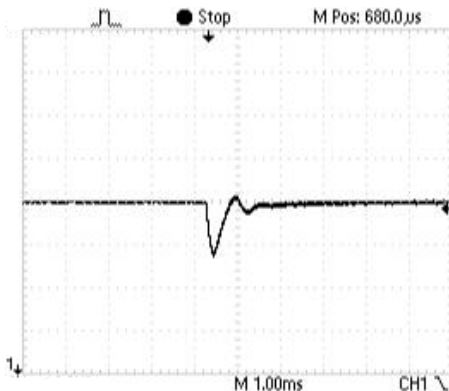

Figure below shows a typical output voltage response, measured during a transition from no load current to full rated load current with no additional output filtering.



#### REMOTE ON/OFF CONTROL

The On/Off control pin allows the user to shut down the converter mechanically or logically using a relay or a TTL or CMOS logic signal.

Connect Remote On/Off pin to -Input when not in use to ensure proper operation.

Resistor R1 can be calculated by:

$$R1 = \frac{(+ \text{ Input} - 5)}{1\text{mA}}$$

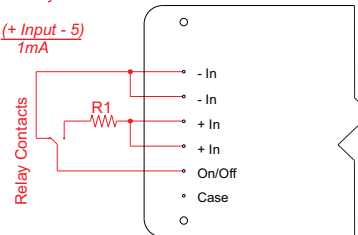

Converter Off:  $V_c > 3V_{dc}$   
 Converter On:  $V_c < 1.5V_{dc}$

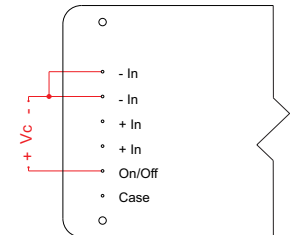

**NOTE:**  
 Do not exceed 6Vdc on remote On/Off. otherwise, the supply may be permanently damaged.

#### OUTPUT CONFIGURATIONS

Due to the unique independently isolated outputs of the X150 series both Output #1 and Output #2 may be connected in a wide variety configurations. The Figures below are some examples.

Dual Positive Output

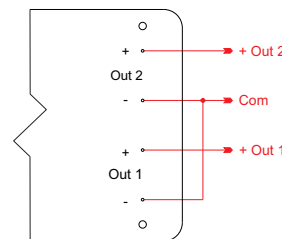

Dual Negative Output

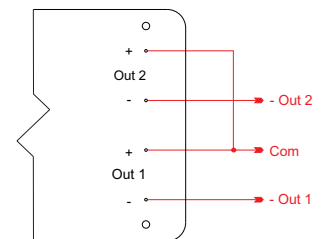

Bipolar Output

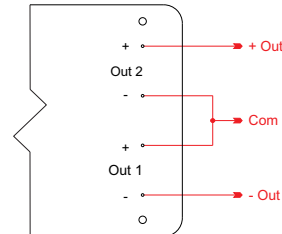

Outputs > 500Vdc

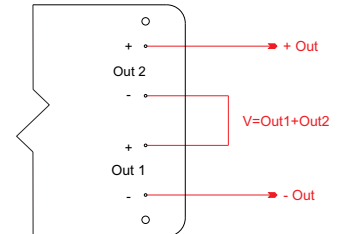



## X150 SERIES 150 WATT HIGH VOLTAGE DC/DC CONVERTERS

### APPLICATION NOTES

#### CONNECTION IN PARALLEL

The figure below shows how to connect several single output units with equal nominal output voltage in parallel.

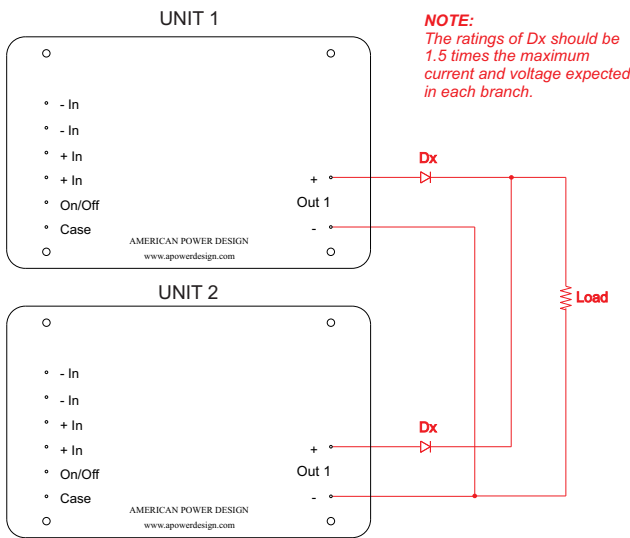

The figure below shows how to connect several dual output units with equal nominal output voltage in parallel.

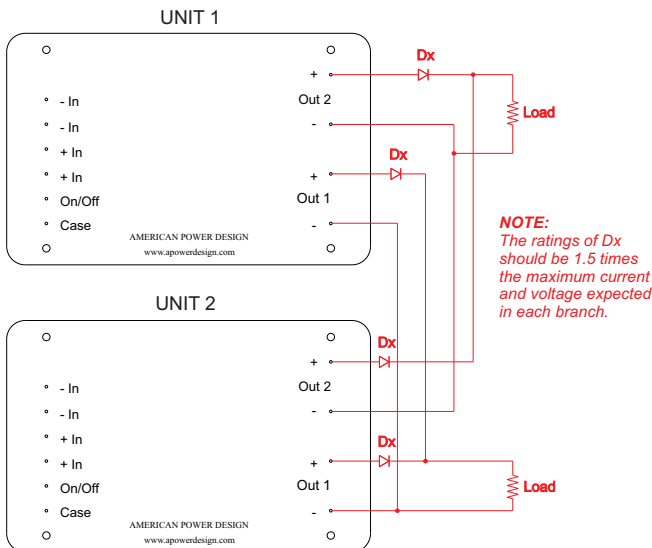

#### CONNECTION IN SERIES

When connecting units in series, the highest achieved output voltage should remain below the rated isolation voltage.

Figure below shows how to connect multiple single output units in series with the use of shunt diodes.

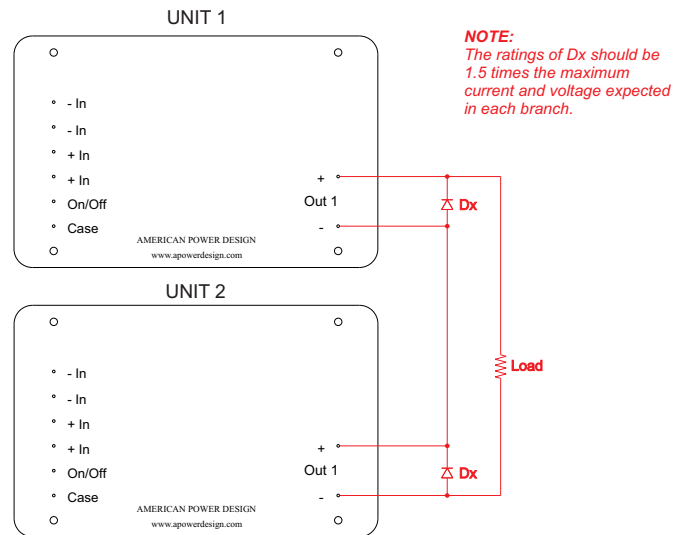
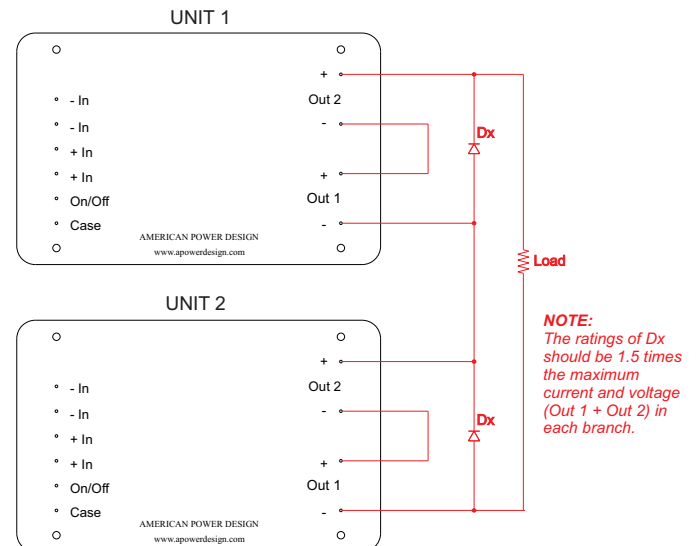

Figure below shows how to connect multiple dual output units in series with the use of shunt diodes.





## X150 SERIES 150 WATT HIGH VOLTAGE DC/DC CONVERTERS

### APPLICATION NOTES

#### CLEANING AGENTS

In order to avoid possible damage, any penetration of cleaning fluids must be prevented, since the power supplies are not hermetically sealed.

#### NUCLEAR AND MEDICAL APPLICATIONS

American Power Design products are not designed, intended for use in, or authorized for use as critical components in life support systems, equipment used in hazardous environments, or nuclear control systems without the express written consent of American Power Design, Inc.

#### TECHNICAL REVISIONS

The appearance of products, including safety agency certifications pictured on labels, may change depending on the date manufactured. Specifications are subject to change without notice.

#### SAFETY REQUIREMENTS

The converters are designed to meet North American and International safety regulatory requirements per UL 60950-1/CSA 22.2 No. 60950-1-07 Second Edition, IEC 60950-1:2005, and EN 60950-1:2006. Basic Insulation is provided between input and output. To comply with safety agencies requirements, an input line fuse must be used external to the converter. The table below provides the recommended fuse rating for use with this family of products.

Input Voltage Range	Fuse Rating
18-36Vdc	10 A
20-60Vdc	9 A
36-72Vdc	5 A

If one input fuse is used for a group of modules, the maximum fuse rating should not exceed 20A.

#### WARRANTY

All products manufactured by American Power Design, Inc. (APD) are warranted to be free of defects due to material or workmanship for a period of one year from date of shipment. At our option, APD will repair or replace any non-conforming product.

APD expressly disclaims any liability for consequential or incidental damages resulting from the use or misuse of its products by the purchaser or others.

This warranty is in lieu of all warranties expressed or implied, including the warranties of merchantability. No other warranties, obligations, or liabilities are expressed or implied.

All products being returned for repair require a return material authorization(RMA) assigned by APD prior to return shipment.